

AFLOWT

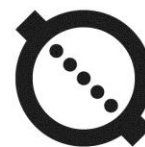

ULTRASONIC FLOW METER
AFLOWT UF

(with clamp-on converters)
VERSION UF-5xx d

**OPERATION MANUAL
PART II**



ISO 9001:2015

TABLE OF CONTENTS

	Page
INTRODUCTION.....	3
1. OPERATING the Flowmeter.....	4
1.1. Controlling Indication	4
1.2. Entering Settings Values and Commands	6
2. Configuring prior to operation	7
2.1. Entering setting values for clamp-on PEAs.....	7
2.2. Defining zero offset dT0.....	7
2.3. Determining the Additional Lag (Padd)	8
2.4. Settings for Processing of Measurement Results	8
2.5. Flowmeter Date and Time Correction	9
2.6. Setting Transition to "Daylight Saving" / "Standard" Time Mode.....	9
2.7. Setting KC and Kp factors.....	9
3. Operation procedure	11
3.1. Displaying calculated values.....	11
3.2. Controlling Batching.....	11
3.3. Viewing logs and historical data.....	13
4. TROUBLESHOOTING	14
APPENDIX A. Display System.....	16
APPENDIX B. Displayed Parameters	25
APPENDIX C. Functions and Identification of Keyboard Keys (Buttons)	33
APPENDIX D. Status Words and Troubleshooting	34

This document covers multichannel ultrasonic flowmeters "AFLOWT UF" of UF-510 d, -520 d, -522 d versions with clamp-on converters, and is intended as a guide for its proper use.

LIST OF ABBREVIATIONS

CS	- Secondary measuring converter
PS	- Pipeline section
ER	- Error
PEA	- Electro-acoustic converter
USS	- Ultrasonic signal.

NOTE. Words in the text marked in bold, for example, **Settings** correspond to the items displayed on the flowmeter's screen.

1. OPERATING THE FLOWMETER

Flowmeter's operation in various modes can be controlled from the CS (secondary measuring converter) keyboard via the hierarchical menu system and indication windows shown on the display, or from a PC either via serial RS-232, RS-485 interfaces or via Ethernet.

1.1. Controlling Indication

1.1.1. To control the flowmeter from the CS keyboard, you use the hierarchical menu system (see Appendix A) consisting of the main menu, submenus and windows which give access to the lists of commands and options. The composition and structure of the main menu (Fig.1) is constant. Number and contents of submenus and windows as well as settings available for modification depend on the flowmeter's operating mode.

1.1.2. The CS keyboard has eighteen buttons, functionality and description of which are given in Appendix C.

The keyboard allows you to do the following:

- Navigate the hierarchical menu and windows
- Efficiently control indication on the display
- Input configuration data
- View data and status logs.

1.1.3. The display shows the menu (window) name which is displayed in the first line of the LCD indicator, and menu items (options) which can be moved up or down (see Fig.1).

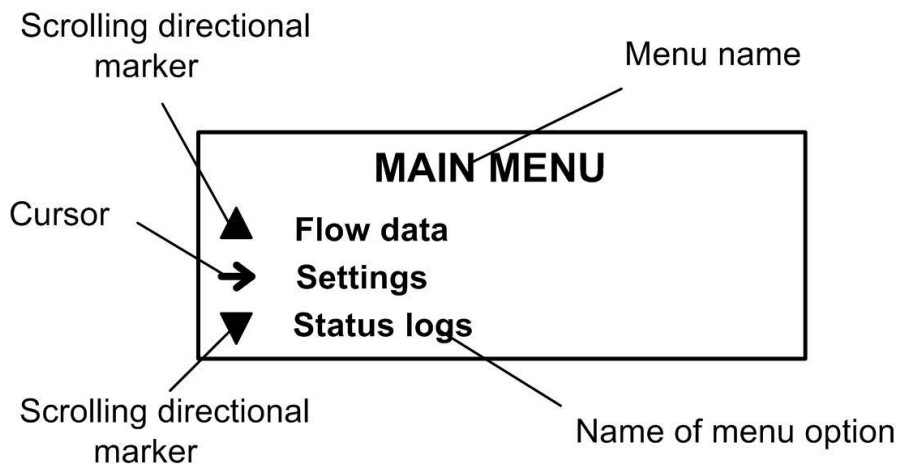















Fig.1. The Main menu.

1.1.4. To indicate a selected menu item, an option, a digit of a number or a substring being edited you use the cursor. The cursor appearance and position depend on whether it possible to modify the data indicated in the current line. Your options:

- ➔ - To navigate to a low-level menu (window)
- ▶ - To modify a setting or a command (status) shown in this line





- - It is impossible to modify the setting (for some settings, it is possible to zoom indication in)
 - - To modify a digit which has the blinking cursor under it
 - ◀ ▶ - To modify the part of a line contents in angle brackets.
- 1.1.5. Number of lines (menu items, list options) indicated on the display cannot exceed 3 at a time. Scroll direction indicators may therefore be shown at the beginning of the first and the last lines of menu items (or options). These indicators are triangles (see Fig.1) with vertexes showing the directions where the cursor can navigate through the lines (menu items, and settings).
- Buttons ,  let you scroll the list up or down to select a menu item (a setting).
- When you press the button  for the first time the cursor moves one line up and stops between the scroll direction indicators. Subsequent pressings of the  button start scrolling menu items (setting), the cursor and the scroll direction indicators being fixed at that time. When the last menu item (setting) is reached the cursor moves to the last line and stops in the place of the lower scroll indicator.
- The procedure of searching the list in the opposite direction using button  is similar.
- 1.1.6. To navigate to a lower level menu (window) or to activate a menu item (a setting) you need to set this menu item (a setting) and the cursor  (▶) in the same line and press button .
- To return to a parent window (menu) press button .
- To leave active state without changing a setting value, press button , while pressing button  first lets you give a new value to a setting.
- 1.1.7. Several menus (windows) which have similar contents but different ownership can be subsequently displayed in one menu (window). Menu (window) ownership is indicated by the sequential number of output, record in the menu (window) name line in the log or by specifying the historical record logging range.
- Whether sequential search of related menus (windows) is enabled, it is indicated by symbol  to the left of the menu (window) which contains the sequential number. To navigate to another related menu (window) use buttons , .
- 1.1.8. You may choose the font of greater size to display settings and measured values. The window with zoomed indication opens after selecting the name of a parameter and pressing button .





1.2. Entering Settings Values and Commands



1.2.1. To modify a setting value or a command you shall open an appropriate menu (window), match the required line of the list with the cursor that

looks like ► and press button . You can set a new value either digit by digit (numeric value) or by selecting it from the list.

1.2.2. Entering a numeric value digit by digit.







If you are setting a numeric value digit by digit, then after pressing button  cursor ► will transform to a blinking cursor = positioned under the first digit of a numeric value, or digit by digit setting window will open with a similar blinking cursor = under the first digit of a number. To modify an existing value you have either to enter a new setting value using buttons  ...  or to change digits on their positions using buttons , .

Pressing button  () once makes the digit marked by the cursor to increase (decrease) by one. To move the cursor to another digit, press buttons , .

By pressing button  you enter the assigned numeric setting value, while pressing button  will cancel the procedure (return back to a previous value).

1.2.3. Entering a setting value, a command or an identifier by selecting from a list.

If a setting value (command, identifier) is selected from a list, then after pressing button  cursor ► will transform into triangle brackets ◀ ► around the setting value (command, identifier) which now can be modified.

Pressing buttons ,  or ,  allows you to navigate through the values. By pressing button  you can enter the assigned numeric setting value, pressing button  enables you to cancel the procedure (return back to the previous value).

2. CONFIGURING PRIOR TO OPERATION

2.1. Entering setting values for clamp-on PEAs

Open **Settings / Main settings** menu and enter:

- **Converter: Clamp-on** – PEA type
- **Mount. mode: Z-mode** or **V-mode** – PEA mounting configuration.

Open **Settings / Main settings / Install. settings** menu and enter the following setting values for each channel:

- **Lcirc** – average outside diameter circumference of the pipeline section
- **Do** – average outside diameter of the pipeline section
- **Dtr** – average outside diameter of the pipeline section in the longitudinal plane of PEAs
- **Wall mat** – wall material of the pipeline section
- **hw** – average PS wall thickness
- **Coat. mat.** – lining material of the pipeline section
- **hcoat** – pipeline section lining thickness
- **Axial dist. calc.** submenu
- **Lx** – measured distance between acoustic centres of the PEA pair along the pipeline axis
- **d** – value of equivalent asperity of the inner wall of the pipeline section
- **v** – kinematic viscosity of the liquid in the pipeline
- **U** – phase velocity for the PEA pair.

Axial dist. calc. submenu is used to enter the ultrasound velocity in the measured medium **Cx** and read the recommended value **Lx**.

2.2. Defining zero offset dT0

- 2.2.1. Zero offset **dT0** shall be defined when the flow in the pipeline is fully stopped. Open **Settings** menu and select **Calibration / Zero calibration / Automated / Run calibr** line. Start calibration procedure by selecting **Start** value. After calibration is stopped (to do this assign **Stop** value to **Run calibr** setting) and the device returns to **ZERO CALIBR. chan. X** window, **dT0** setting will be automatically set to the value calculated by the flowmeter.

In case it is impossible to absolutely stop the flow of liquid in the pipeline, you may determine zero offset as follows:

- When the flowrate value lies in the range $0.1Q_{max} - Q_{max}$ the **dT0** setting is defined according to the foregoing procedure – dT_{01}
- For clamp-on PEA pairs with connected cables are reciprocally swapped instead.

The required value of zero offset is calculated from the formula:

$$dT_0 = 0.5 (|dT_{01}| - |dT_{02}|), \mu s.$$

- 2.2.2. The calculated value is assigned to the **dT0** setting in the flowmeter and recorded to the log. After that, the initial installation of clamp-on PEAs is restored.

2.3. Determining the Additional Lag (Padd)

The **Padd** setting value is determined as follows. Open **Settings** menu and select **Calibration / Add. delay calibr. / Padd CALIBR. chan. X** line and enter tabular value of sound velocity **Cref**. After that, you need to activate **Automated** option and start calibration procedure (set **Start** value for **Run calibr.** parameter). After calibration procedure is stopped (to do this specify **Stop.** value for **Run calibr** setting) and you return to **Padd CALIBR. chan. X** window, **Padd** setting will be automatically set to the value calculated by the flowmeter.

The calculated value of **Padd** setting is logged into the check form which is given in the Installation Manual.

NOTE. When measuring flowrate in water and heat supply systems, the ultrasound velocity is determined in accordance with Appendix D of the Installation Manual. When measuring flowrate of other liquids, the ultrasound velocity is determined according to GSSD tables for measured liquids or using special device (see Fig.D.1 in Appendix D of the Installation Manual). The ultrasound velocity shall be entered into the flowmeter 5 minutes after determining at the latest.

2.4. Settings for Processing of Measurement Results

2.4.1. Open **Settings / Processing settings** menu and enter setting value:









- **Median** – median averaging buffer size
- **Mean** – arithmetic averaging buffer size
- **KP** – exponential filter factor (0.95 by default)
- **Inert. time** – lag (it is not advisable to set it to less than 10 s)
- **Accel.** – maximum speed of flow velocity variation
- **Cut.** – minimal flowrate cutoff
- **LW** – low setpoint for flowrate
- **UP** – high setpoint for flowrate
- **Vmax** – correction of the flowrate values up to which volume calculation is performed
- **Flow sign** – liquid flow direction sign
- **Units** – flowrate (volume) dimension
- **Config.** – flowmeter configuration.

2.4.2. It also necessary to check whether the displayed flowrate sign ("**+**" or "**-**") corresponds with the actual flow direction in the pipeline. In case it does not correspond, it is necessary to check the correctness of either PEA pair mounting or PEA pair connection considering the flow direction. If mounting and connection are performed correctly, you shall check **Flow sign** setting value (sign).

2.4.3. **Settings / System settings / Connection settings** and **Settings / Periphery settings** menu lets you configure settings to coordinate work of flowmeter outputs with inputs of connected devices and equipment (see Figs A.6, A.7 in Appendix A and tables B.4, B.5 of Appendix B).

In case of necessity, **Settings / System settings / Total flow reset** lets you perform the totalizer zeroing procedure.

2.5. Flowmeter Date and Time Correction

To adjust date and time you shall select and activate **Settings / System settings / Time settings / Date (Time)**, and then using buttons ,  set the cursor **-** to "day", "month", "year" ("hours", "minutes", "seconds") positions. Using buttons  ...  or ,  modify selected setting value in each position. Press button  to enter the setting value, and to cancel entering (to return to previous value) press button .

2.6. Setting Transition to "Daylight Saving" / "Standard" Time Mode

2.6.1. The flowmeter is capable of setting the device clock to "Daylight Saving" / "Standard" time automatically. The user can:

- Set the device clock transition mode
- Turn off the device clock transition functionality.

Two device clock transition modes are provided: standard and user-defined.

In standard mode, the transition to "daylight saving" time takes place at 2:00:00 a.m. of the last Sunday of March the clock being put one hour forward, and to "standard" time at 3:00:00 a.m. of the last Sunday of October the clock being put one hour back. In user-defined mode, the user can set the transition time. In case the transition functionality is turned off the device clock keep time countdown according to "standard" time only.

2.6.2. To set the transition mode, activate **Settings / System settings / Time settings / Time mode change / Mode** option and select one of the following values: **standard** or **user-defined**.



In the Standard mode, you may see the date and time of automatic transitions to "daylight saving" and "standard" time in **Daylight saving time** and **Standard time** windows, respectively.

In the User-defined mode, you can set time of transition to "daylight saving" and "winter" time in **Daylight saving time** и **Standard time** windows, respectively, following instructions in p.1.2.2.



If **Mode** setting is set to **no change** then **Daylight saving time** and **Standard time** menu items become unavailable.

2.7. Setting KC and Kp factors

2.7.1. The **KC (Kp)** factor is calculated in **Settings / Periphery settings / Universal output X (Type frequency) / Setup / FREQUENCY OUTPUT X (PULSE OUTPUT X)** menu.

To calculate the **KC** factor, open **FREQUENCY OUTPUT X** menu and first enter **Qut**, **Qlt** и **Fmax** values according to p.1.2. After that, using buttons ,  align **KC calcul. ...** line with the cursor  and

press the  button. Dots in the end of **KC calcul. ...** line become enclosed in the triangle brackets ◀ ▶.

To start the calculation procedure you need to press  button and then, after dots within the triangle brackets are substituted with the **Start** word –  button. Consequently, **Start** is again substituted with dots, and one line up the **KC** value is displayed.

2.7.2. To calculate the **Kp** factor open menu **PULSE OUTPUT X** and enter values for **Qut** and τ settings. Calculation procedure for **Kp** is similar to that for **KC**.







If the calculated **KC (Kp)** value does not suit the user for whatsoever reason he can set a lesser value for **KC** (and a greater – for **Kp**). Meanwhile, **Qut**, **Qlt** and **Fmax (Qut and τ)** values do not change.

If, considering the frequency (pulse width), the **KC (Kp)** value is set to a wrong value, the alarm message will appear.

3. OPERATION PROCEDURE

3.1. Displaying calculated values

The user can operate the flowmeter via either keyboard and display or RS-232 / RS-485 interface.

- 3.1.1. After powering on the flowmeter the CS display shows the device information. Upon self test completion the main menu is displayed with the cursor → opposite to the line **Flow data**.
- 3.1.2. Press button  to switch to displaying of measured values, buttons ,  – to select the required channel number, and buttons ,  – to select the characteristic to be displayed. To switch to zoomed indication of measured values hover the cursor ■ over the required characteristic name and press button .
- 3.1.3. After putting into operation the flowmeter works in the automatic mode.
- 3.1.4. Zoomed indication window contains, besides the setting name, measurement units and the setting value, part of the sign-position code of the current channel status word. The complete channel status word (see table D.1) is displayed in menu **Status logs / Current status (CURR. STATUS chan. X)**.





To determine the alarm situation (ER) type that occur in the measurement channel and is displayed in the window of zoomed indication of measured value as the " x " character in the status word, open window **Status logs / Current status (CURR. STATUS chan. X) / ER (ER chan. X)** of the corresponding channel. Besides the ER type name, this window will display the ER duration and date and time of ER start.



3.2. Controlling Batching

- 3.2.1. There are two ways of batching:
 - Batching of preset amount of liquid
 - Batching in the "start-stop" mode.
- 3.2.2. The ways to preset volume of liquid are:
 - To enter **Ve** setting value before batching
 - To select one of the batching options **BATCH1 ... BATCH8** values of which are entered and stored in the flowmeter beforehand.

To enter the **Ve** value, it is necessary to:

 - Select the way to preset the batch – (**Flow data / Batching / Sel. batch**)
 - Activate option **Ve**
 - Enter batch value – to carry out actions defined in p.1.2.2.

Activate option **Sel. batch** and using buttons ,  or   choose one of the batching options in the emerged triangle brackets

  . After that, press button  . Selected batch value will be displayed in the **Ve** option line. Batch values for **BATCH1...BATCH8** are entered in the window **SETTINGS / Batch list / BATCH SETUP X** before batching process starts.

Batching process starts when operator gives the command to batch using either the CS keyboard or serial interface. Batching process stops automatically when the preset batch value is accumulated or when the operator gives the command (before the preset batch is accumulated).

3.2.3. To make "start-stop" batching possible assign zero value to **Ve** value. The operator starts and stops batching via serial interface or using the CS keyboard.

3.2.4. Batching procedure

The word **START** in **Flow data / Batching / BATCHER X / Batch** line shows that batching process has not started yet. To start batching process select **Batch** option pressing button .

After this, batching process starts and lower level window **BATCH. X** opens displaying **IN PROCESS** in the same line with the window name. Additionally, this window displays the preset **Ve**, and measured **Vb** batch volume values and batching time **Tmeas**.

Batch accumulation stops either when accumulated volume equals the preset value or when the operator gives the command. In the "start-stop" mode, the batching process stops only when the operator gives the command.

To stop the batching process, select option **Ctrl.** in this window, and press button  . After the batching process has been stopped words **IN PROCESS** are substituted by the word **COMPLETED**, **STOP** in line **Ctrl.** changes to **START**, and lines **Vb** and **Tmeas** display the measured batch volume and the corresponding batching time.





Next start of the batching process is performed by pressing button  too. Values of settings **Vb** and **Tmeas** are nullified, **COMPLETED** is replaced with **IN PROCESS**, and **START** – with **STOP**.

3.2.5. Upon batching completion (after the preset batch volume is accumulated or the batching process is stopped by the operator) the flowmeter:

- Produces through a universal output when batching is completed a pulse or a logical signal, parameters of which depend upon the output working mode
- Writes the measured batch volume, batch accumulation time, average batching volumetric flowrate, batching start and stop date and time values to the batching log.

Batching does not affect measuring and logging of current values.

3.3. Viewing logs and historical data

- 3.3.1. To view log records, select the log type **Data logs / View data logs / DATA LOGS CHANNEL X / Hourly log (Daily log, Monthly log, Interval log, Batch log)**. Then select the required log interval using buttons ,  and view logged values pressing buttons , .

The last line of hourly, daily, monthly and interval logs contains the **Record search** option. Upon selecting this option window **LOG RECORD SEARCH**, opens, and the cursor moves to the line displaying the log interval.

To find a record, activate the line and enter the required log interval. In case the entered interval is present in the log you will move to this (or the nearest) interval by pressing button . If it is not present, the last line will display the message: **No search conducted**.

- 3.3.2. To view log records, select the log type **Status logs / Error logs (Failure log, Mode log)**. The procedure to view log records is the same as for records in archives.

The last line in each log contains words **Curr. record**. Activate this line, enter the required record number and press button  to navigate to this record quickly. In case the record with this number does not exist, the display will show the last record.

4. TROUBLESHOOTING

- 4.1. To check the flowmeter functionality most fully make sure that measured values are displayed and that all setting parameters are entered and set within the required range.
- 4.2. In self-test mode, the flowmeter has the automatic monitoring functionality which displays flowmeter status words which register alarm situations, failures and faults.

Current state of the flowmeter measuring channels is displayed in windows **STATUS LOGS / Current status / CURR. STATUS chan. 1(2)** as the following status words:

- **ER** – alarm situation measuring channel status word
- **DS** – output status word
- **FL** – failure status word.

Also, the ER status word is displayed in windows of zoomed indication of measured parameters current values.

Status word is displayed as a sign-position code – a combination of characters " - " и " x ". Character " - " shows that an event did not occur, character " x " – that it did.

Status word contents, possible causes of some faults and ER situations, and troubleshooting methods are described in Appendix D.

To determine the type of the ER situation that occurred in a measuring channel and is displayed in the measured value zoomed indication window, open window **STATUS LOGS / Current status (CURR. STATUS chan. X) / ER (ER chan. X)** of the corresponding channel. Besides the ER situation type name, this window shows the ER situation start time and duration.

- 4.3. An ER situation is an event characterized by mismatch of measured values and flowmeter metrological characteristics, or by impossibility of measurements due to the violation of measurement conditions. An ER situation is registered when its duration exceeds 1 second.

Secondary measuring converter processes ER situations as follows: when the ER situation occurrence condition is met character " x " shows in the certain place of the status word (error message), and upon completion the ER situation start time, end time and duration is recorded to the archive. The **Inert. time** ER situation (alarm condition) is not recorded to archives.

The flowmeter power supply failure is also recorded to an archive.

Depending on the ER type the CS can stop flowrate measuring, volume accumulating and recording dead time values. The CS starts recording dead time value when volume accumulation is stopped.

- 4.4. Ultrasonic signal (USS) failure is processed depending on the ratio of USS failure duration and the preset setting value **Inert. time** in menu **SETTINGS / Processing settings**, which can be set between 5 and 300 s.

Upon USS failure in the measuring channel, ER **Inert. time** is recorded to the status word, accumulation of liquid volume stops and the last measured flowrate value continues to display.

In case signal failure duration is less than the preset lag, ER situation **Inert. time** is cancelled and, after the USS signal appears again, the average flowrate value for the USS failure period is calculated. Average flowrate value calculation uses the last value measured before USS failure, and the first value measured after the USS appeared again. Calculated average value is used to calculate increment of volume during the USS failure. The calculated volume increment is added to the volume value (batch) accumulated by the time of USS failure. After that, flowrate measuring and volume (batch) accumulating continues.

In case USS failure duration exceeds the lag time, ER situation **Inert. time** is cancelled, ER **No signal** is recorded, volume accumulating stops, zero flowrate value is displayed the dead time counter starts counting. When USS appears back the flowmeter resumes flowrate measuring and accumulating volume (batch) starting from the volume (batch) value, accumulated by the time of USS failure. USS failure is recorded to the ER log, and the dead time value is increased by the USS failure duration value.

- 4.5. In case the flowrate value exceeds the preset upper limit value or is less than the lower limit value, the ER with the same name is registered, and accumulating of volume and flowrate measuring continue.

If the flowrate value has exceeded the value corresponding to flow velocity **V_{max}** set in menu **SETTINGS / Processing settings**, then ER **Q>Q_{max}** is registered, volume accumulating and logging stops while measuring and displaying of the measured flowrate value continues.

- 4.6. In case of failure or an ER first of all check the following:
- power supply is fully operational, the flowmeter input voltage meets the specifications;
 - Power circuits are reliably connected
 - Liquid is present and running through the pipeline
 - There is no gas (air) bag in the place of PEA installation.

If all the requirements listed above are met contact the service centre or manufacturer for the information about the device's operability.











- 4.7. "AFLOWT UF" Flowmeter should be repaired by authorized dealers or by the manufacturer.

APPENDIX A. Display System

Menu and window system and relationships between them are shown in Figs.A.1-A.9. Notation used in these figures is shown in table A.1.

List of settings, number of displayed digits and possible values of displayed values can be found in Appendix B.

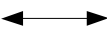
Table A.1.

Element type	Application
SETTINGS	Menu name
Flow rate	Menu item, command or setting name.
X, XXX	Uneditable numeric value of a setting, or editing is performed in another window.
	Setting numeric setting value editable digit-by-digit.
<i>condition</i>	Settings value is set by the flowmeter. Displayed words represent the setting essence meaning.
< <i>command</i> >	Setting value is set by user by selecting it from the list. Words within angle brackets represent the essence meaning or possible values of a setting.
	Window or menu item (setting) is displayed only in the SETUP mode.
	Window or menu item (setting) are displayed in modes SERVICE and SETUP.
Icon  representing the mode is missing	Window or menu item (setting) is displayed in all modes: OPERATION, SERVICE, SETUP.
	Setting (settings) modification or transition to the lower level window is possible only in SETUP mode.
	Setting (settings) modification or transition to the lower level window is possible only in SERVICE and SETUP modes.
Icon  representing the mode is missing	Setting (settings) modification is possible in all modes: OPERATION, SERVICE, SETUP.
	Window of the integrated indication and input of value of parameter.
	Window of the integrated indication.
	Transition between windows.
 <i>Fig. A.1</i>	Indicator of the transition to another figure.

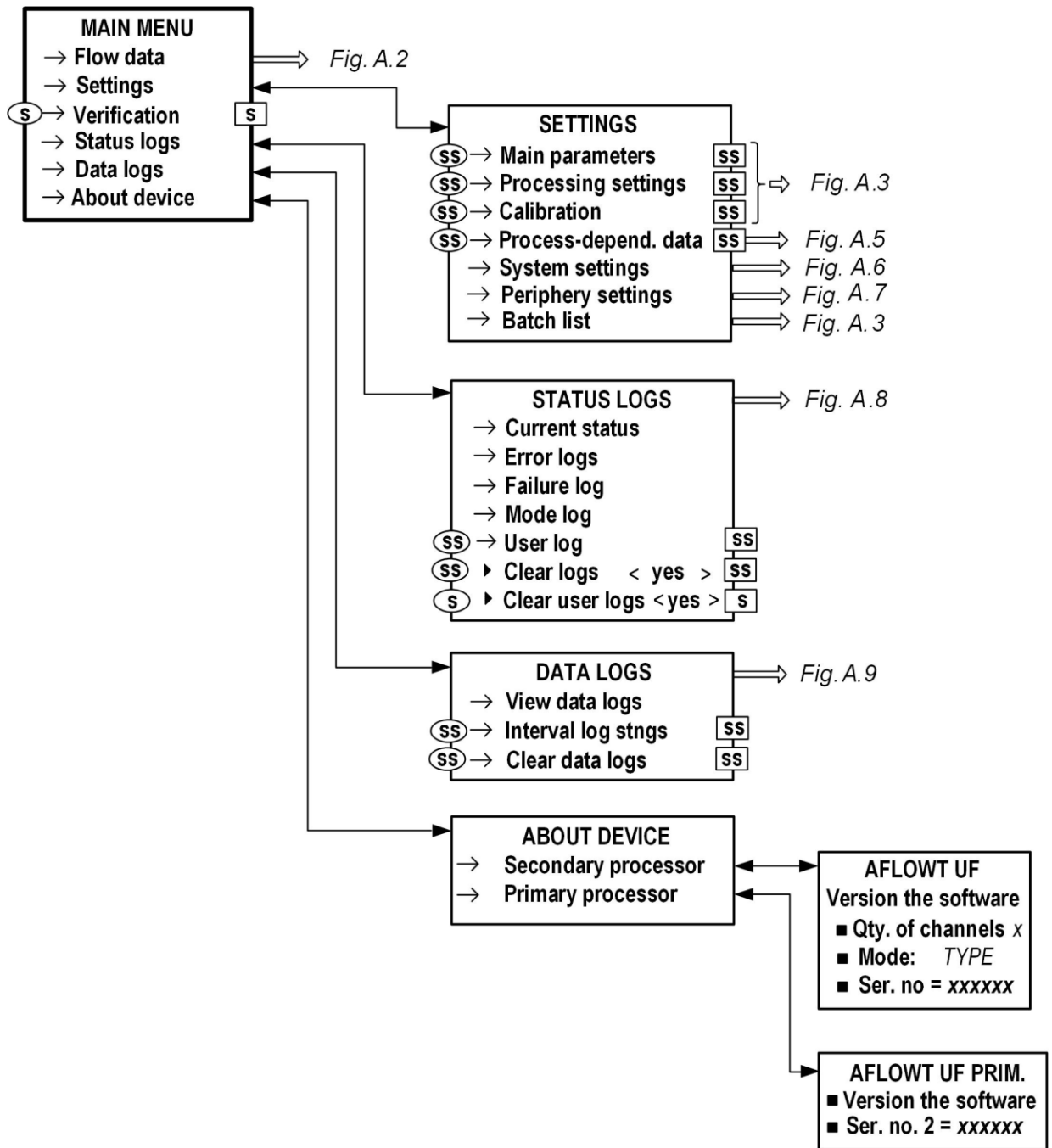

Fig.A.1. Main menu

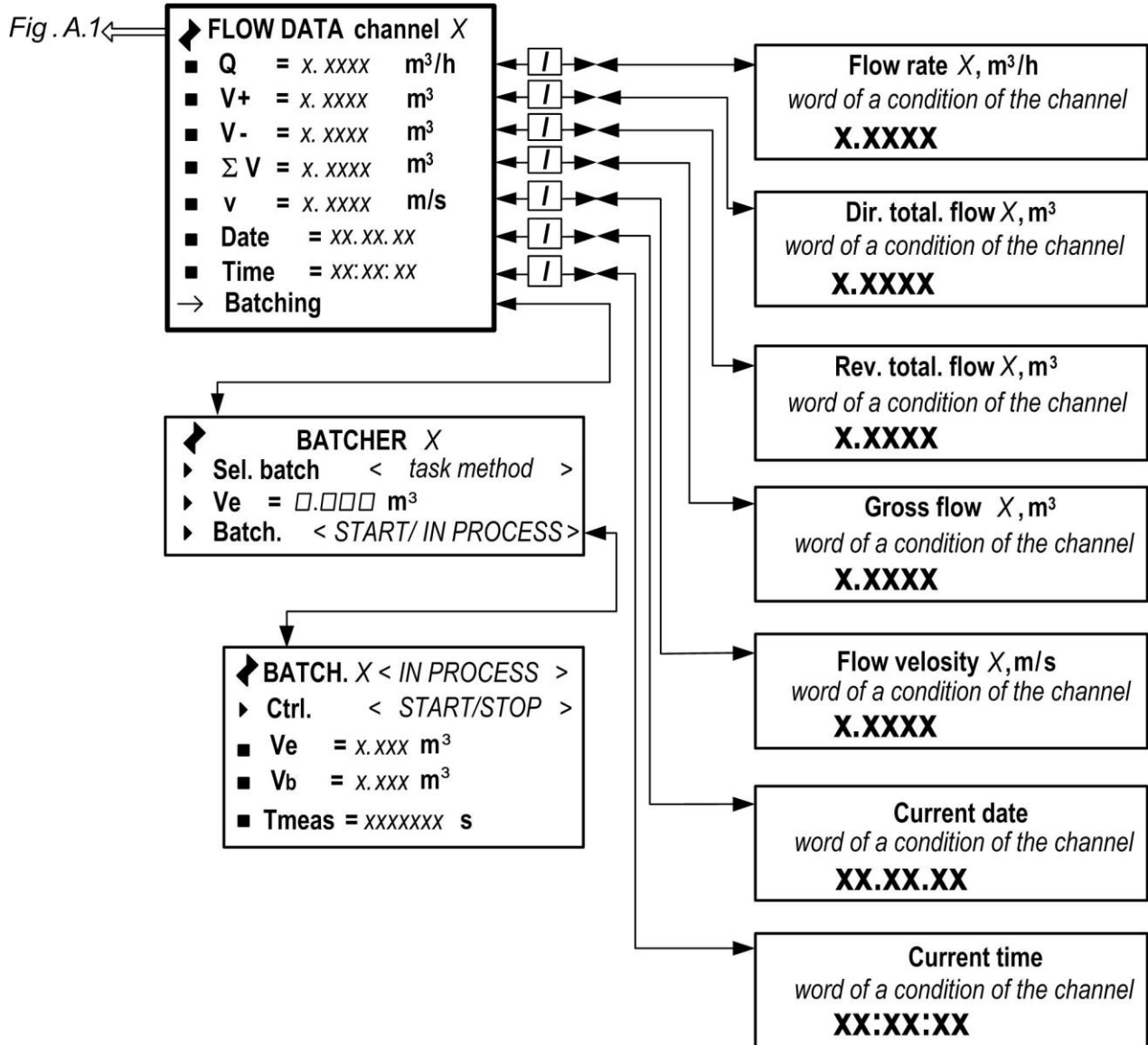
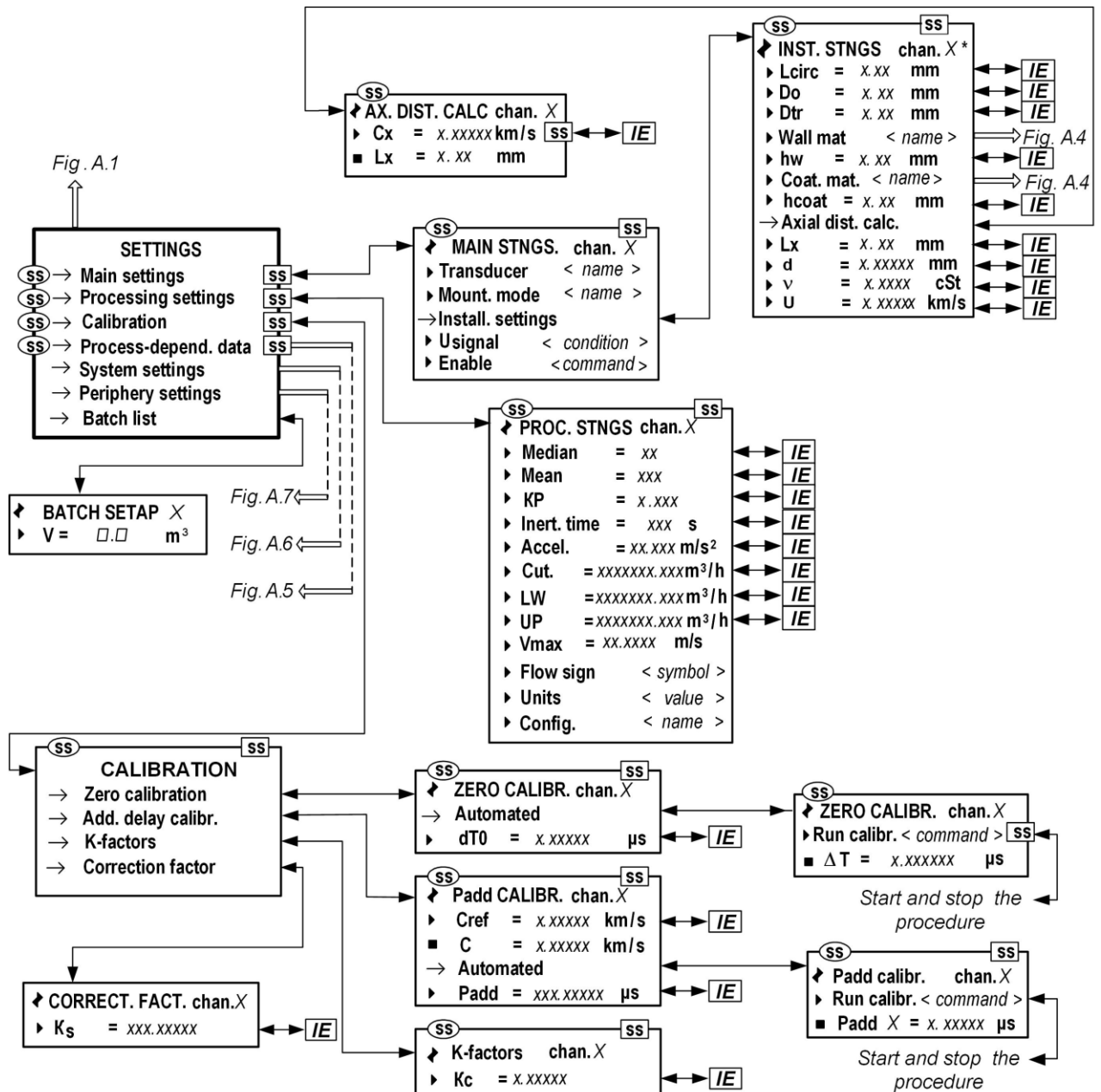

Fig.A.2. Menu "FLOW DATA"



* - the set of parameters is determined by the PEA hookup scheme in **MAIN STNGS. chan. X** menu (see table. B.3)

Fig.A.3. Menus and windows for indicating characteristics of the pipeline section, adjusting signals, and processing measurement and calibration results

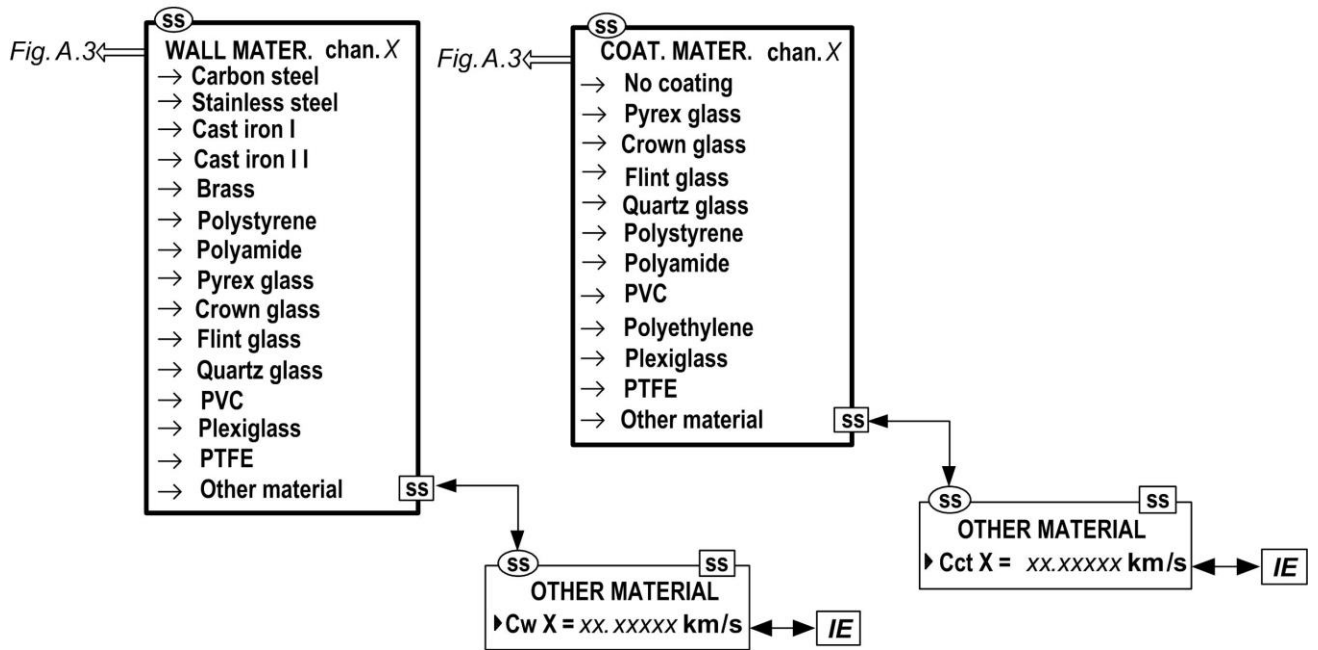

Fig.A.4. Menu "WALL MATER." and "COAT. MATER."

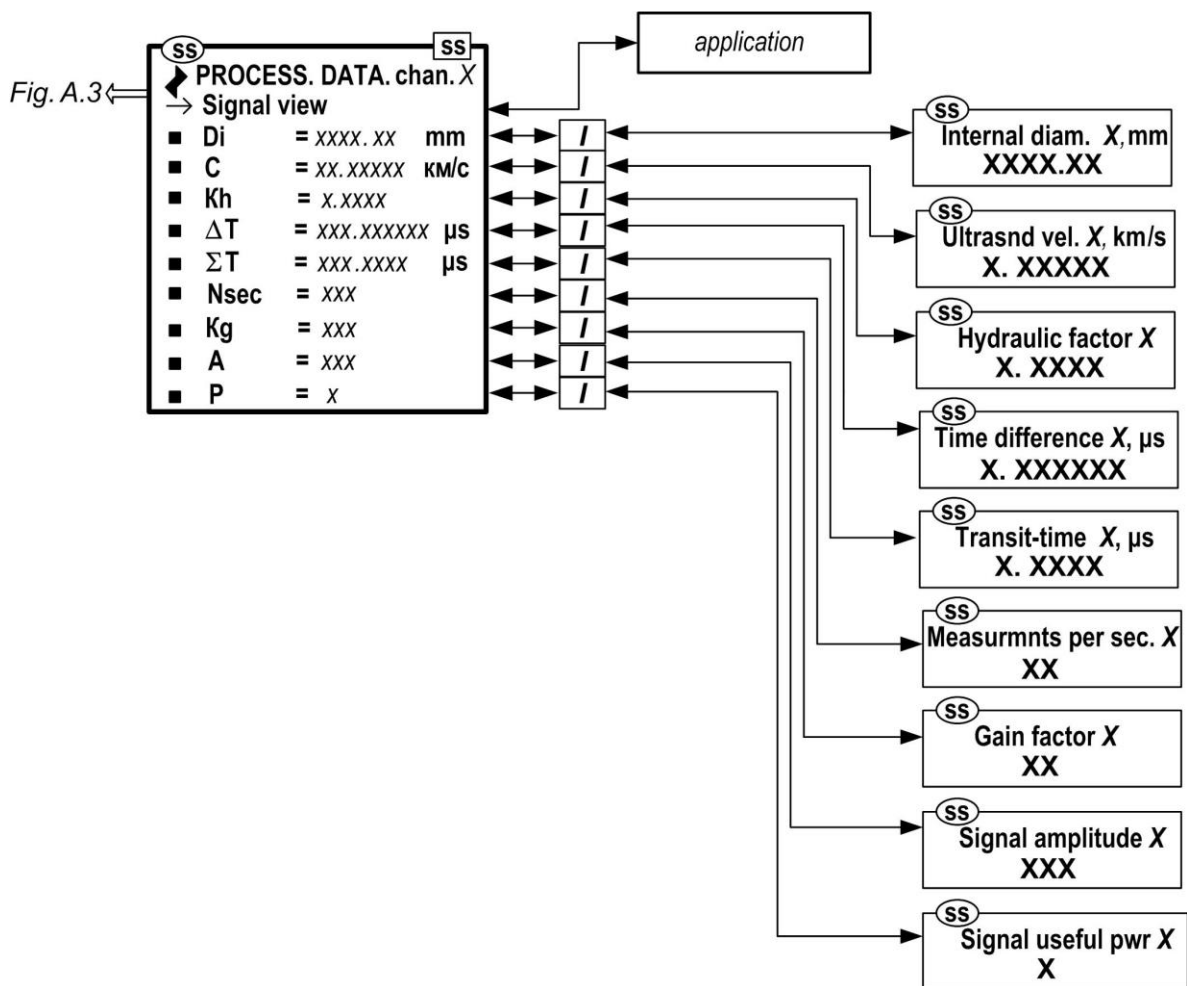
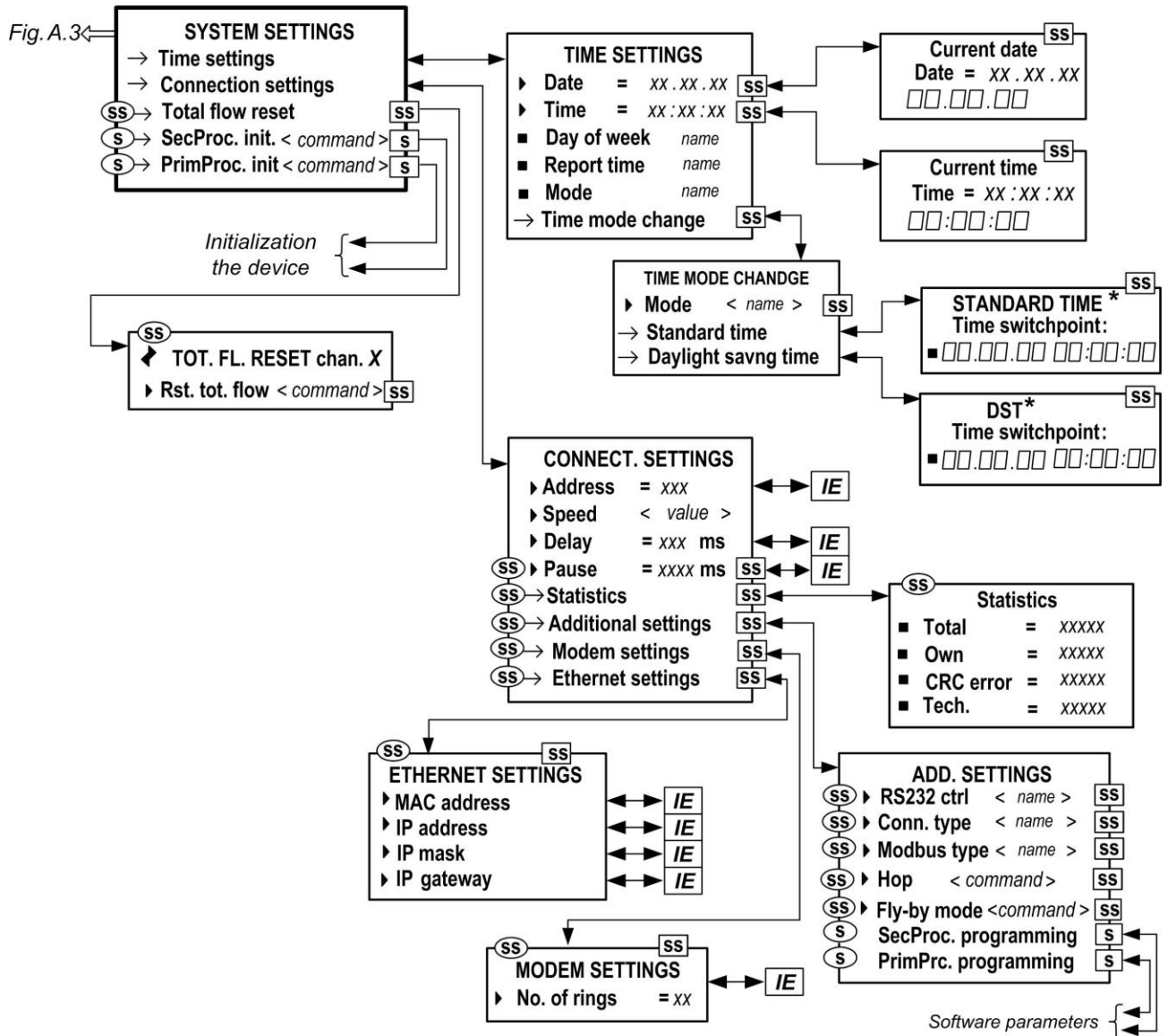

Fig.A.5. Menu « Process-depend. data »



* - not displayed in case **Mode** setting is assigned **no change** value.

Fig. A.6. Menu "SYSTEM SETTINGS"

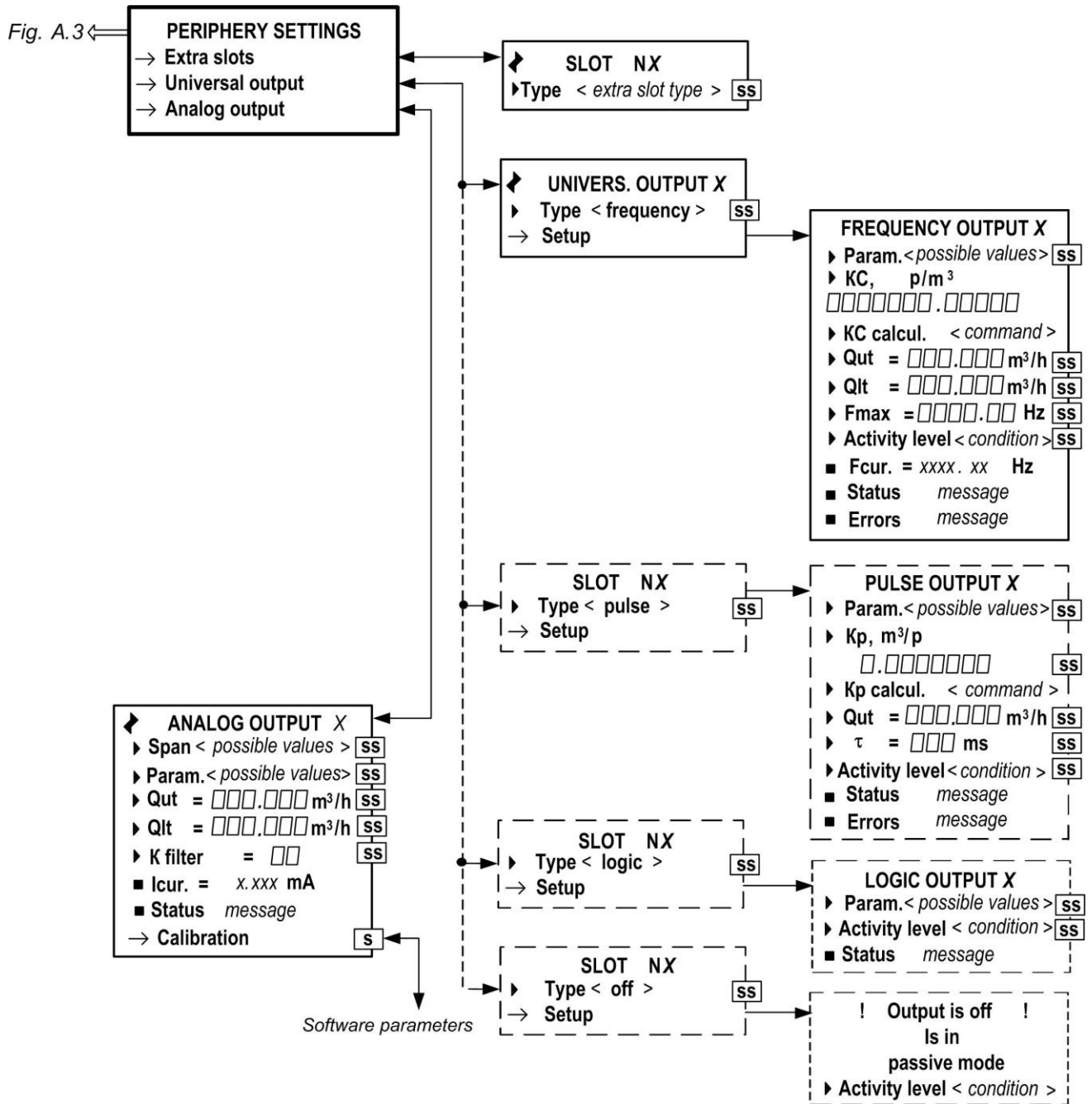

Fig.A.7. Menu "PERIPHERY SETTINGS"

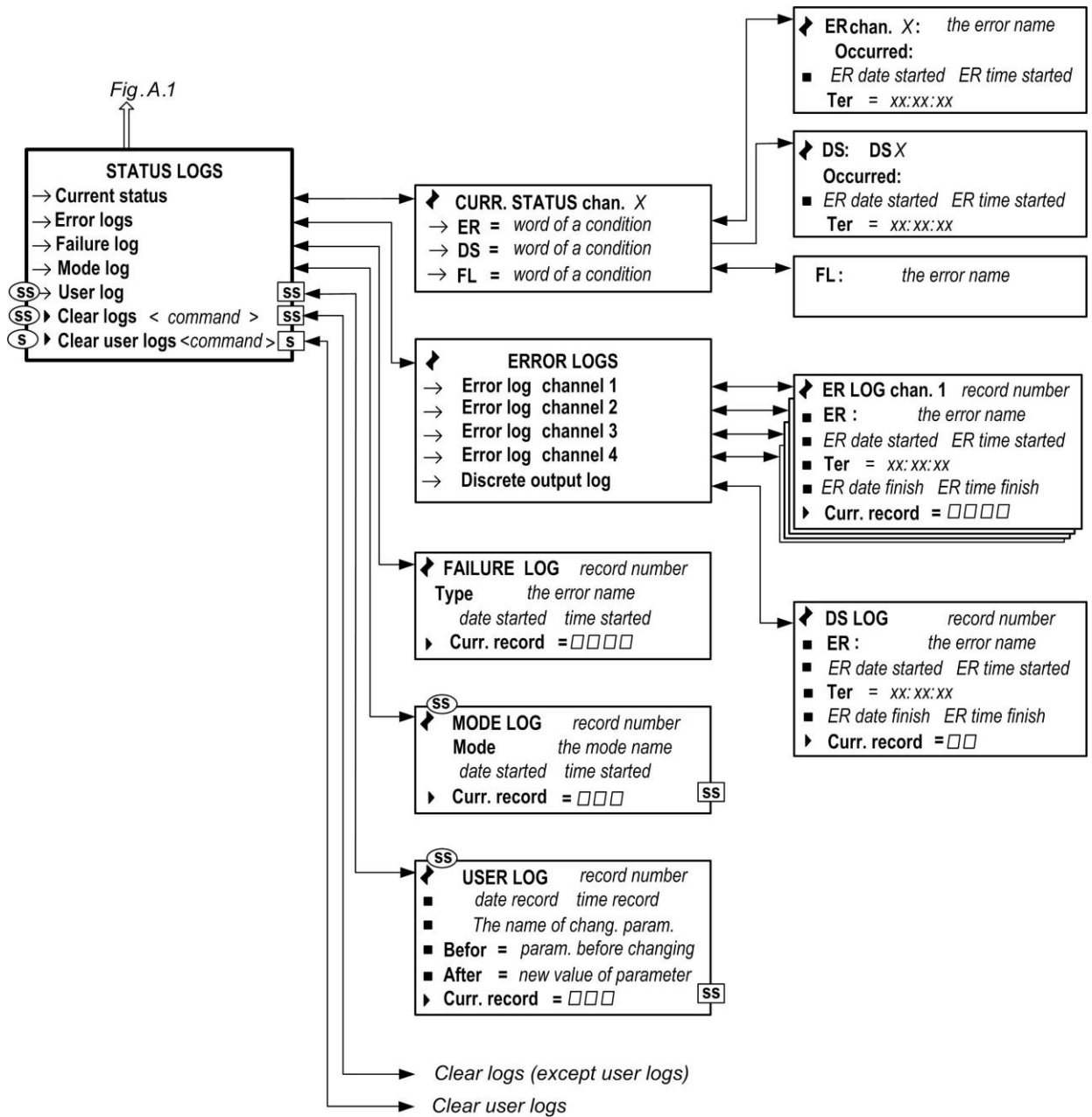

Fig.A.8. Menu "STATUS LOGS"

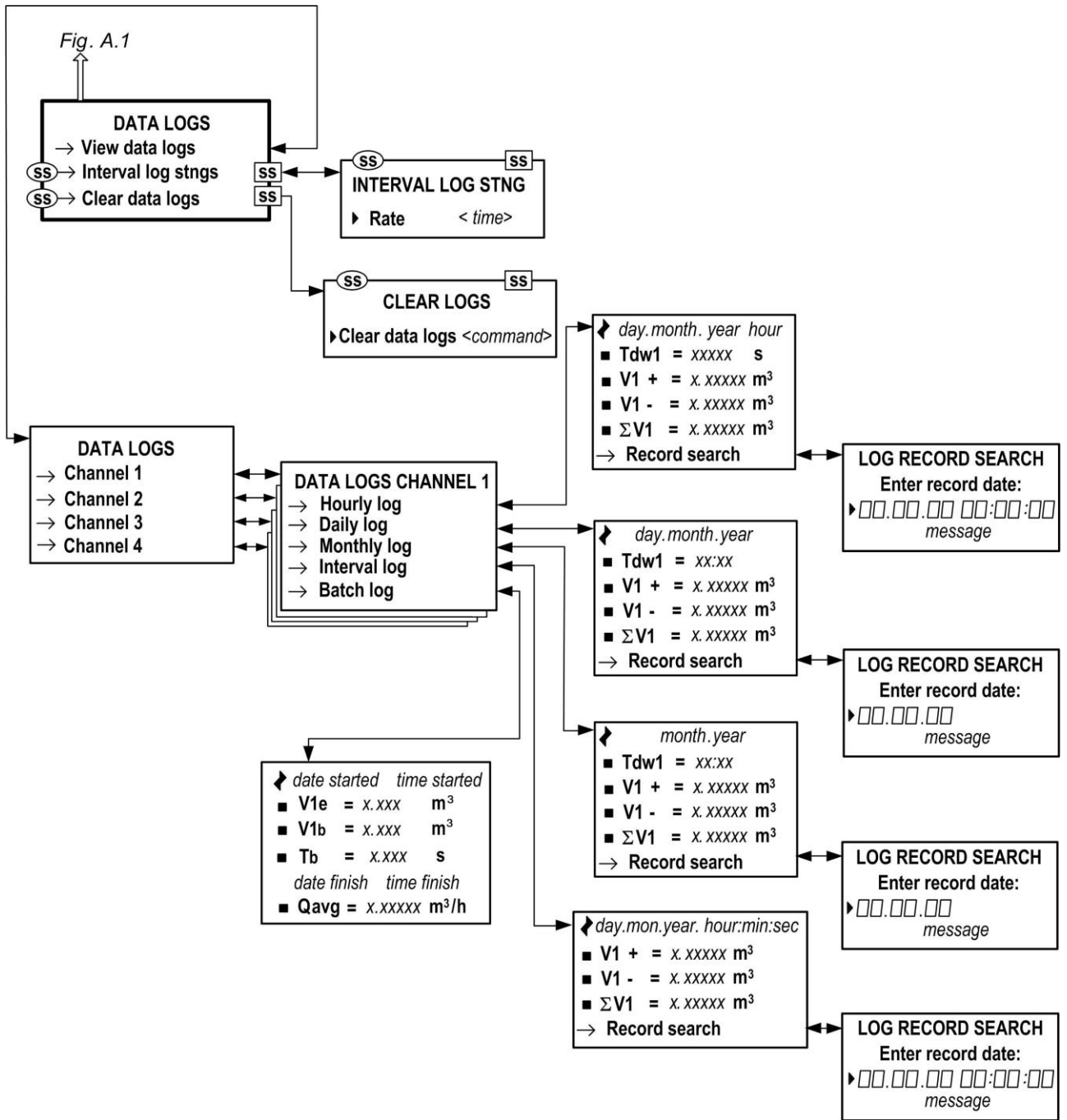

Fig.A.9. Menu "DATA LOGS"

APPENDIX B. Displayed Parameters

Table B.1. Menu "FLOW DATA" (Fig.A.2)

Representation of the parameter being displayed	Parameter Name, measurement units	Number of displayed digits, representation form		Notes
		integer part	fractional part	
FLOW DATA				
Q	Average volumetric flowrate, m ³ /h (m ³ /s, l/min)	7	4	
V+	Volume for direct flow, m ³ (l)	10	4	
V-	Volume for reverse flow, m ³ (l)	10	4	
ΣV	Total volume considering the flow direction, m ³ (l)	10	4	
v	Flow velocity, m/s	3	4	
Date	Current date (flowmeter time)	XX.XX.XX (dd.mm.yy)		
Time	Current time (flowmeter time)	XX:XX:XX (hh:mm:ss)		

Table B.2.

Representation of the parameter being displayed	Parameter Name, measurement units	Allowed values	Value after initialization	Notes
BATCHER				
Sel. batch	Batch setting method: setting of value or selecting a preset value	ENTERED; BATCH1 (2,...,8)	ENTERED	
Ve	Preset batch value, m ³ (l)	0,000-100000000	0	
Batch.	Command to start or the process status	START; IN PROCESS	START	
Ctrl.	Command to start or the process status	START; STOP	START	
Vb	Measured batch value, m ³ (l)	0,000- 9999999,999	0	
Tmeas	Batch accumulation time, s	0-4294967	0	

Table B.3. Main parameters, additional parameters of result processing and calibration (Fig.A.3)

Representation of the parameter being displayed	Parameter Name, measurement units	Allowed values	Value after initialization	Notes
1	2	3	4	5
MAIN STNGS.				
Transducer	PEA type	Clamp-on	does not change	
Mount. mode	PEA installation chart	Z-mode; V-mode	does not change	
Install. settings	Transition to window INST. STNGS	-	-	
U signal	Probing signal voltage	high; low	does not change	
Enable	Enables measurements	no; yes	does not change	
f3	Signal digitization frequency	20 MHz, 10MHz, 6,67 MHz, 5 MHz	20 MHz	
INST. STNGS				
Lcirc	Average circumference value for the outer diameter of the pipeline, mm	31,42-50265	does not change	
Do	Average outer pipeline diameter value, mm	10.01-15999.85	does not change	
Dtr	Average outer pipeline diameter value in the longitudinal plane of PEA installation, mm	10-16000	does not change	
Wall mat	Pipeline wall material	list	Carbon steel	
hw	Average value of pipeline wall thickness, mm	0,01-99,99	1	
Coat. mat.	Material of the inner coating of the pipeline	list	No coating	
hcoat	Thickness of the inner coating of the pipeline, mm	0,00-99,99	0	
Axial dist. calc.	Datum axis calculation (transition to window AX. DIST. CALC)	-	-	
Lx	Distance between centres of radiating planes of PEA along the pipeline axis, mm	10,00-16000	does not change	
d	Inner surface equivalent asperity, mm	0,00000-10	0,01	
v	Kinematic viscosity of liquid, cSt	0,0000-5000	1	
U	Average PEA phase velocity value, km/s	1,482-4,850	3,85	
AX. DIST. CALC				
Cx	USS velocity preset for calculation, km/s	0,00000-6	does not change	

Cont. of Table B.3.

1	2	3	4	5
PROC. STNGS				
Median	Number of measurements to determine the median value	1-15	7	
Mean	Number of measurements to determine the arithmetic mean value	1-200	200	
KP	Exponential filter factor	0-1	0,95	
Inert. time	Minimal duration of the event recorded to logs, s	5-300	10	
Accel.	Maximum speed of variation of flow velocity in the pipeline, m/s ²	0,001-10	10	
Cut.	Cutoff by the minimal flowrate, m ³ /h (m ³ /s, l/min)	0-9999999	0	
LW	Low setpoint for flowrate, m ³ /h (l/min)	0-9999999	0	
UP	High setpoint for flowrate, m ³ /h (l/min)	0-9999999	5	
Vmax	Correction of the flow velocity, m/s	0-99,9999	10.6000	
Flow sign	Liquid flow direction sign	- ; +	+	
Units	Flowrate (volume) measurement units	m ³ /h (m ³); l/min (l); m ³ /s (m ³)	m ³ /h (m ³)	
Config.	Flowmeter configuration	Multichan. Multipath.	Multichan.	
CALIBRATION				
dT0	Zero offset, μs	-999,999- -999,99987	0	
Cref	Reference ultrasound velocity, km/s	0,00000-6,00000	1,48270	
C	Measured ultrasound velocity, km/s	0,00000-99,99999	-	
Padd	Additional lag in the USS channel, μs	-999,999- 999,999	does not change	
Kc	Calibration factor	0-100	1	
Ks	Calibration factor	0-100	1	
BATCH SETUP				
V	Preset batch value, m ³ (l)	0-1000000	0	

Table B.4. Menu "SYSTEM SETTINGS" (Fig.A.6)

Representation of the parameter being displayed	Name, measurement units of the parameter	Allowed values, representation form	Value after initialization	Notes
1	2	3	4	5
TIME SETTINGS				
Date	Current flowmeter date	XX.XX.XX (dd.mm.yy)	does not change	
Time	Current flowmeter time	XX:XX:XX (hh:mm:ss)	does not change	
Day of week	Current flowmeter week day	Mo, Tu, We, Th, Fr, Sa, Su	does not change	
Report time	Flowmeter time type	std., DST	does not change	
Mode	Flowmeter clock transition mode to "Daylight Saving" and "Standard" time	standard, user-defined, no change	does not change	
Time mode change	Flowmeter clock transition mode to "Daylight Saving" and "Standard" time	XX.XX.XX XX:XX:XX	does not change	
CONNECT. SETTINGS				
Address	Flowmeter address in the RS-interface network	1-247	1	
Speed	Transfer rate, Baud	1200; 2400; 4800; 9600; 19200; 38400; 57600; 115200	19200	
Delay	Lag for response via interface, ms	0-125	50	
Pause	Idle time between sending bytes, ms	1-1000	5	
Statistics				
Total	Total amount of requests to all devices in the network	0-65535	0	
Own	Number of requests to this flowmeter	0-65535	0	
CRC error	Number of errors during data exchange	0-65535	0	
Tech.	Number of requests to the primary transducer	0-65535	0	
ADD. SETTINGS				
RS232 ctrl	Mode	no; bidir.; unidir.	unidir.	
Conn. type	RS-232 cable diagram	direct; modem	direct	
ModBus type	ModBus Protocol Type	RTU; ASCII	RTU	
MODEM SETTINGS				
No. of rings	Number of calls to establish a modem connection	31	NO MODEM	
ETHERNET SETTINGS				
MAC address	MAC address	00-00-000 (99-99-999)	00-00-000	
IP address	IP address	000-999	000	
IP mask	IP mask	000-999	000	
IP gateway	Gateway IP address	000-999	000	

Table B.5. Menu "PERIPHERY SETTINGS"(Fig.A.7)

Representation of the parameter being displayed	Parameter Name, measurement units	Allowed values	Value after initialization	Notes
1	2	3	4	5
SLOT NX				
Type	Type of the module installed in the slot	Discrete Analog Universal o/p Empty	Empty	
UNIVERS. OUTPUT X				
Type	Universal output operation mode	off logic pulse frequency missing	missing or off	
FREQUENCY OUTPUT (Setup)				
Param.	Output function (parameter identifier)	see Table B.6	no	
KC	Output conversion factor, pulse/m ³ (pulse/l)	0,0001-5·10 ⁶	1000,0	
Qut	Upper limit by flowrate for the universal output in the frequency mode, m ³ /h (l/min, m ³ /s)	0-999999,93	300	
Qlt	Lower limit by flowrate for the universal output in the frequency mode, m ³ /h (l/min, m ³ /s)	0-999999,93	0	
Fmax	Maximum output frequency, Hz	0-3000	3000	
Active level	Output voltage level when the signal is present (logical 1)	low; high	low	
Fcur.	Current frequency value	0-3000	-	
Status	Output status	intact; faulty	intact	
Errors	Output operation characteristic	no errors; F > Fmax; sett.viol. yes	no errors	
PULSE OUTPUT (Setup)				
Param.	Output function (parameter identifier)	see Table B.6	no	
Kp	Pulse weight, m ³ /pulse (l/pulse)	0,0000002-10 ⁵	0,001	
Qut	Upper limit by flowrate for the universal output in the pulse mode, m ³ /h (l/min, m ³ /s)	0-999999,93	300	
τ	Pulse width, ms	1-500	1	

Cont. of Table B.5

1	2	3	4	5
Active level	Output voltage level when the signal is present (logical 1)	low; high	low	
Status	Output status	intact; faulty	intact	
Errors	Output operation characteristic	no errors; pulse>norm	no errors	
LOGIC OUTPUT				
Param.	Output function (parameter identifier)	see Table B.6		
Active level	Output voltage level when the signal is present (logical 1)	low; high	low	
Errors	Output status	intact; faulty	intact	
ANALOG OUTPUT				
Span	Output operation range, mA	0-5; 0-20; 4-20	4-20	
Param.	Output function (parameter identifier)	see Table B.6		
Qut	High setpoint by flowrate for current output, m ³ /h (l/min)	0-999999,93	300	
Qlt	Low limit by flowrate for current output, m ³ /h (l/min)	0-999999,93	0	
Icur	Current value of current, mA	0,001	-	
Kfilter	Filtration factor	0-40	1	
Status	Output operation characteristic	no errors value > UT value < LT	no errors	

Table B.6. Allowed functions for pulse, frequency, logical and current outputs

Name of the parameter	Identification in line Param.	Possibility to set the function for the output			
		current	Universal output		
			frequency	pulse	logical
1	2	3	4	5	6
Output closed	no	×	×	×	×
Flowrate for direct flow	Qx+	×	×		
Flowrate for reverse flow	Qx-	×	×		
Flowrate for any flow direction	Qx	×	×		
Volume for direct flow	Vx+			×	
Volume for reverse flow	Vx-			×	

Cont. of Table B.6

1	2	3	4	5	6
Volume for any flow direction	Vx			×	
Signal upon batching completion	pul. batcher x			×	
Reversing flow direction	sign x				×
No ultrasonic signal	no signal x				×
Flowrate exceeds the high set-point	Q > Q_{upx}				×
Flowrate is less than the low setpoint	Q < Q_{lw x}				×
Flowrate exceeds the upper limit	Q > Q_{ut}				×
Flowrate is less than the lower limit	Q < Q_{lt}				×
Flowrate exceeds the maximum flowrate value	Q > Q_{max}				×
Active level signal is generated on the output when batching is completed	batcher x				×

Table B.7. Menu "STATUS LOGS" (Fig.A.8)

Representation of the parameter being displayed	Parameter Name, measurement units	Value range, representation form	Value after initialization	Notes
ERROR LOGS				
Ter	Event duration	XX:XX:XX (hh:mm:ss)	0	
-	Data of event start or end	XX.XX.XX (dd.mm.yy)	-	
-	Time of event start or end	XX:XX:XX (hh:mm:ss)	-	
Curr. record	Sequential number of the record to be searched for after entering the new value	1-1000*	does not change	
CURR. STATUS chan. X				
ER	Measuring channel status word	15 character places** (see Table D.1)	-	
DS	Status word of quantized outputs	13 character places** (see Table D.3)	-	
FL	Status word of failures	4 character places** (see Table D.4)	-	

* - Maximum number of records depends on the type of log











** - Character "x" means that event occurred, character "-" that it didn't; positions in status words are enumerated **from right to left**

Table B.8. Menu "DATA LOGS" (Fig.A.9)

Representation of the parameter being displayed	Parameter Name, measurement units	Value range, representation form	Value after initialization	Notes
DATA LOGS (Hourly, daily, monthly, interval logs)				
Tdwx	Dead time: - hourly log, s	0-3596	-	
	- daily log	XX:XX (hh:mm)	-	
	- monthly log	XXX:XX (hh:mm)	-	
Vx +	Volume for direct flow, m ³ (l)	0-999999000	-	
Vx -	Volume for reverse flow, m ³ (l)	0-999999000	-	
ΣVx	Total volume considering flow direction, m ³ (l)	0-999999000	-	
DATA LOG (Batch log)				
Vx e	Preset batch value, m ³ (l)	0-1000000	0	
Vx b	Measured batch value, m ³ (l)	0-9999990	0	
Tb	Batching time, s	0-65535	-	
Qavg	Average flowrate per batching time			
INTERVAL LOG SETTING				
Rate	Interval log range (logging range), mm:ss	5 seconds – 2 hours	6 min	

APPENDX C. Functions and Identification of Keyboard Keys (Buttons)

Table C.1.

Identification	Function
	<ol style="list-style-type: none"> 1. When selecting menu item, parameter, log record, value from the list – navigating up the list. 2. When setting a numeric value – incrementing digit value by one.
	<ol style="list-style-type: none"> 1. When selecting menu item, parameter, log record, value from the list – navigating down the list. 2. When setting a numeric value – decrementing digit value by one.
	<ol style="list-style-type: none"> 1. When digit-by-digit setting of numeric values – moving the cursor along the number digits to the left. 2. When viewing log records – decrementing record number. 3. When searching similar menus (windows) – transition to the menu (window) with less sequential number or to the previous log interval. 4. When selecting menu item, parameter, log record, value from the list – navigating up the list.
	<ol style="list-style-type: none"> 1. When digit-by-digit setting of numeric values – moving the cursor along the number digits to the right. 2. When viewing log records – incrementing the record number. 3. When searching similar menus (windows) – transition to the menu (window) with greater sequential number or to the next log interval. 4. When selecting menu item, parameter, log record, value from the list – navigating down the list.
	<ol style="list-style-type: none"> 1. Transition to the selected menu (window) of lower level. 2. Activation of a menu item (parameter): allowing access to changing a parameter (setting) value, command or to execute an action. 3. Executing an operation, entering set parameter value, command.
	<ol style="list-style-type: none"> 1. Exit to the menu (window) of higher level. 2. Exiting active state: forbidding access to changing a parameter (setting) value, command or to execute an action. 3. Cancelling executing of an operation, entering modified parameter value, command; exiting to the menu (window) of higher level.
 	<ol style="list-style-type: none"> 1. Entering a numeric value of a setting parameter.
	<ol style="list-style-type: none"> 1. Moving the cursor to the fractional part of a number.
	<ol style="list-style-type: none"> 1. Sign of a negative numeric value of a parameter.

APPENDIX D. Status Words and Troubleshooting

When an event occurs the status word shows, in corresponding position, character "x", and when it doesn't occur – character "-". Positions in status words are numbered **from right to left**.

Table D.1. ER status word (measuring channel status word)

Number of the position	Appearance of indication	ER Description
1	F > Fmax	Maximum frequency is exceeded
2	Q > Qmax	Maximum flowrate is exceeded
3	Q > Qut	Flowrate exceeds the current output upper limit
4	Q < Qlt	Flowrate is less than the current output upper limit
5	No signal	USS is not present in the current measuring channel (in the 1 beam)
6	No signal2	USS is not present in the 2 beam
7	No signal3	USS is not present in the 3 beam*
8	No signal4	USS is not present in the 4 beam*
9	Oper.er.	Operator's error in the current measuring channel (in the 1 beam)
10	Oper.er.2	Operator's error in the second beam
11	Oper.er.3	Operator's error in the 3 beam*
12	Oper.er.4	Operator's error in the 4 beam*
13	Q > Qup	Flowrate exceeds the high setpoint
14	Q < Qlw	Flowrate is less than the low setpoint
15	Inert. time	Lag time

* - not used in this version of the flow meter

Table D.2. Status word of quantized outputs (universal outputs)

Number of the position	Appearance of indication	Event description
1	DS0	ER or failure on the universal output 0
2	DS1	ER or failure on the universal output 1
3	DS2	ER or failure on the universal output 2
4	DS3	ER or failure on the universal output 3
5	DS4	ER or failure on the universal output 4
6	DS5	ER or failure on the universal output 5
7	DS6	ER or failure on the universal output 6
8	DS7	ER or failure on the universal output 7
9	DS8	ER or failure on the universal output 8
10	Q < Qlt1	Flowrate is less than the current output 1 lower limit
11	Q > Qut1	Flowrate exceeds the current output 1 upper limit
12	Q < Qlt2	Flowrate is less than the current output 2 lower limit
13	Q > Qut2	Flowrate exceeds the current output 2 upper limit

NOTE.

The following events are registered in the status word of quantized (universal) outputs:

- Frequency corresponding to the current flowrate exceeds the maximum allowed value (in the frequency operation mode)
- Pulse number corresponding to the measured volume value exceeds that which, considering the preset pulse width, can be generated on the output within the interval equal to that of volume measurement (in the pulse operation mode)
- Flowrate value is beyond the set lower or upper limit (in the frequency mode)
- Output failure.

Table D.3. Status word of failures

Number of the position	Appearance of indication	Event description
1	Conn. fail.	Failure of connection with the transducer
2	Clock fail.	The flowmeter clock failure
3	FRAM fail.	External RAM failure
4	FLASH fail	Nonvolatile memory failure

Table D.4. Faults, failures, alarm situations and troubleshooting

Event type	Probable cause	Troubleshooting method
1. Display failure	1. Faulty power supply 2. Faulty prevented.	1. Replace power supply. 2. Replace prevented.
2. No signal	1. Incorrect adjustment of the flowmeter. 2. Pipeline is not filled with liquid, or there's too much gas in the liquid. 3. Faulty electric connections between PEA and CS. 4. Faulty mounting of the clamp-on PEAs on the pipeline. 5. Sediments on the inner surface of the pipeline. 6. Faulty PEA. 7. CS failure.	1. Make sure that the parameters are set correctly. 2. Make sure that the pipeline is filled with liquid, and that there're not considerable air bags present. 3. Check integrity and reliability of electric connections between PEA and CS. 4. Check mounting correctness and quality of fastening of PEAs to the pipeline, and that there is lubricant present under the radiating surface of the clamp-on PEA. 5. Install PEA on another section if the signal level is insufficient. 6. Check functionality of the channel with other PEAs. 7. Contact the Service Center.
3. Q > Qmax	Measured flowrate value has exceeded the allowed value.	Make sure that the parameters are set correctly.
4. Q > Qut	Flowrate exceeds the frequency output upper limit	Make sure that the parameters are set correctly.
5. Q < Qlt	Flowrate is less than the frequency output upper limit	Make sure that the parameters are set correctly.
6. Q < Qlt1; Q < Qlt2	Flowrate is less than the current output lower limit	Make sure that the parameters are set correctly.
7. Q > Qut1; Q > Qlt2	Flowrate exceeds the current output upper limit	Make sure that the parameters are set correctly.
8. F > Fmax	Frequency corresponding to the current flowrate exceeds the maximum allowed value.	Make sure that the parameters are set correctly.
9. Q > Qut	Flowrate exceeds the high setpoint	Make sure that the parameters are set correctly.
10. Q < Qlw	Flowrate is less than the low setpoint	Make sure that the parameters are set correctly.
11. Oper.er.	Wrong PS parameter values	Check correctness of set PS parameters
12. Conn.fail.	Transducer failure.	1. Perform initialization of the product*. 2. Contact the Service Center.
13. Clock fail.	The flowmeter clock failure.	1. Perform initialization of the product*. 2. Contact the Service Center.
14. FRAM fail.	External RAM failure.	Contact the Service Center.
15. FLASH fail	Nonvolatile memory failure.	Contact the Service Center.

* - During flowmeter's initialization the logs are cleared.